

# COMFONY 40

Stool bench 2500

BENKERTBÄNKE



# COMFONY 40

Stool bench 2500

BENKERTBÄNKE

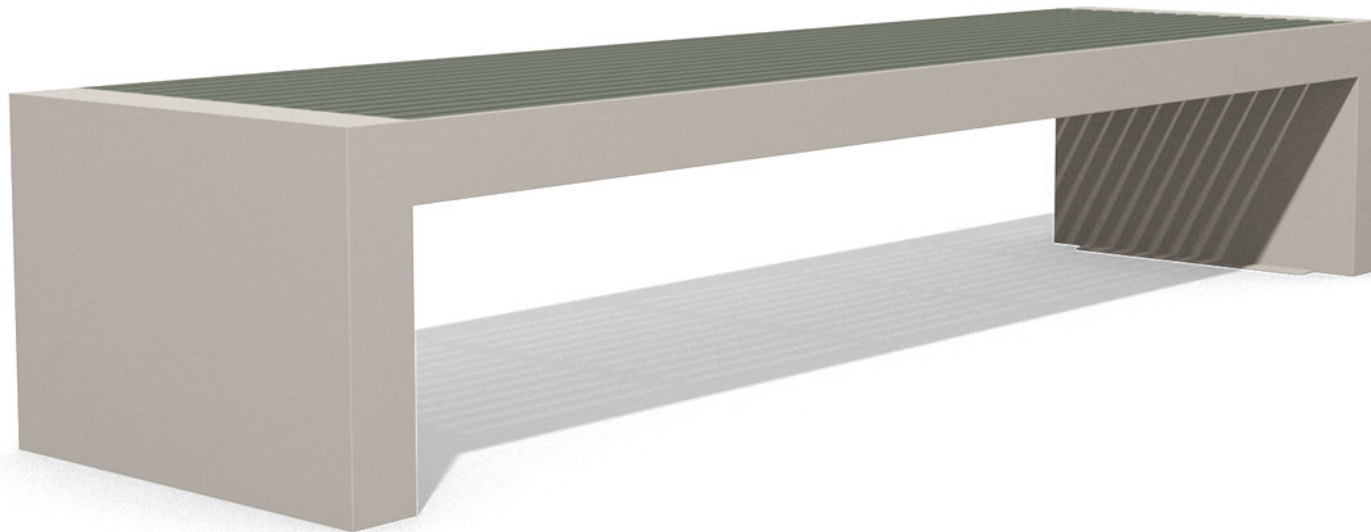

# COMFONY 40

Stool bench 2500

# BENKERTBÄNKE

## GROUND ANCHOR

1. Concrete-in, installation depth 250 mm
2. Bolt-on, installation depth 80 mm

## DIMENSIONS

Length: 2500 mm  
Width: 650 mm  
Height: 465 mm  
Seat height: 465 mm  
Weight: ca. 70 kg

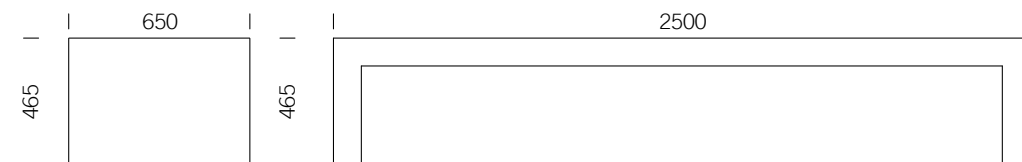

## FRAME

Stainless steel type 304 | powder-coated

## SEAT

Slats consisting of an aluminium tube with a PET-thermo-casing | impact resistant | UV resistant

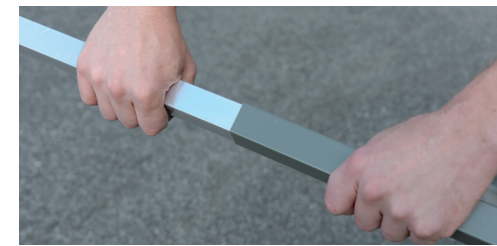
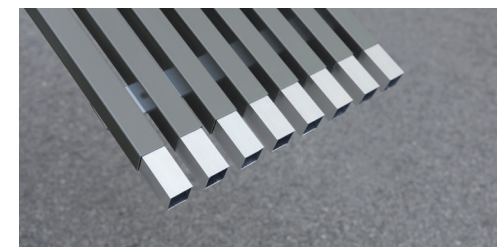
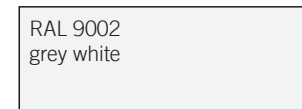
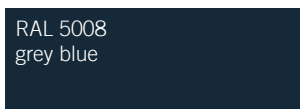
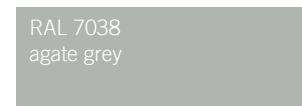
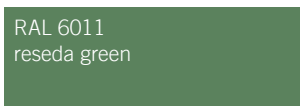
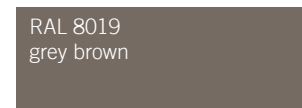
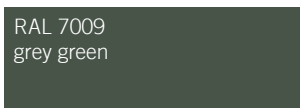
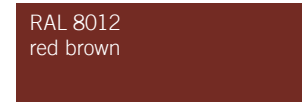
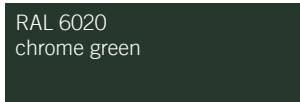

# COMFONY 40

Stool bench 2500

BENKERTBÄNKE

GROUND ANCHOR CONCRETE-IN, INSTALLATION DEPTH 250 MM

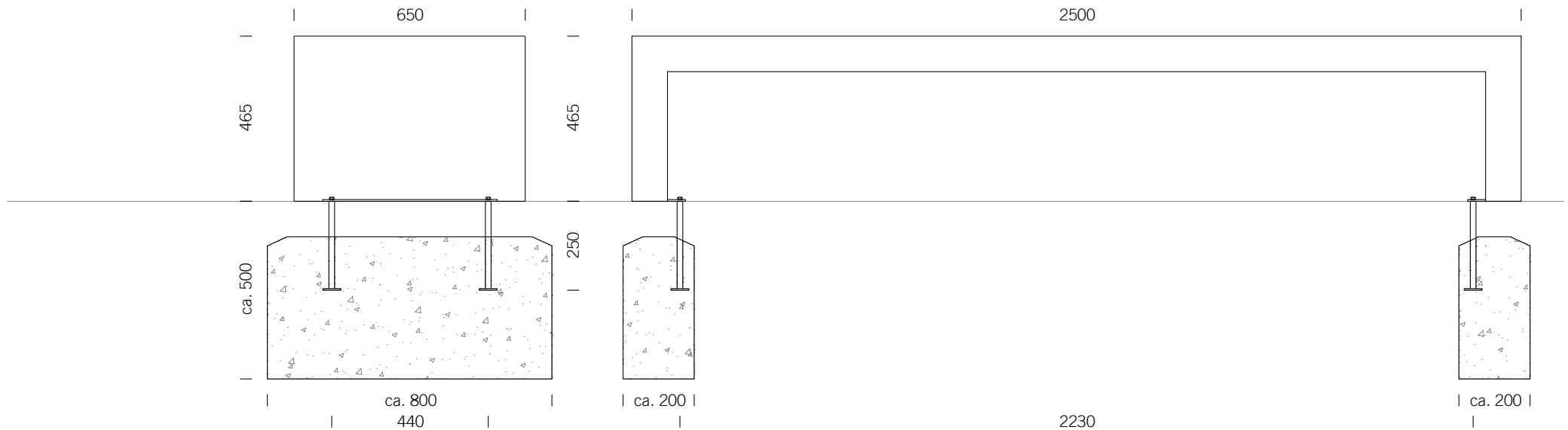

Foundations depend on local conditions - This is only a suggestion without warranty

# COMFONY 40

Stool bench 2500

BENKERTBÄNKE

GROUND ANCHOR BOLT-ON, INSTALLATION DEPTH 80 MM

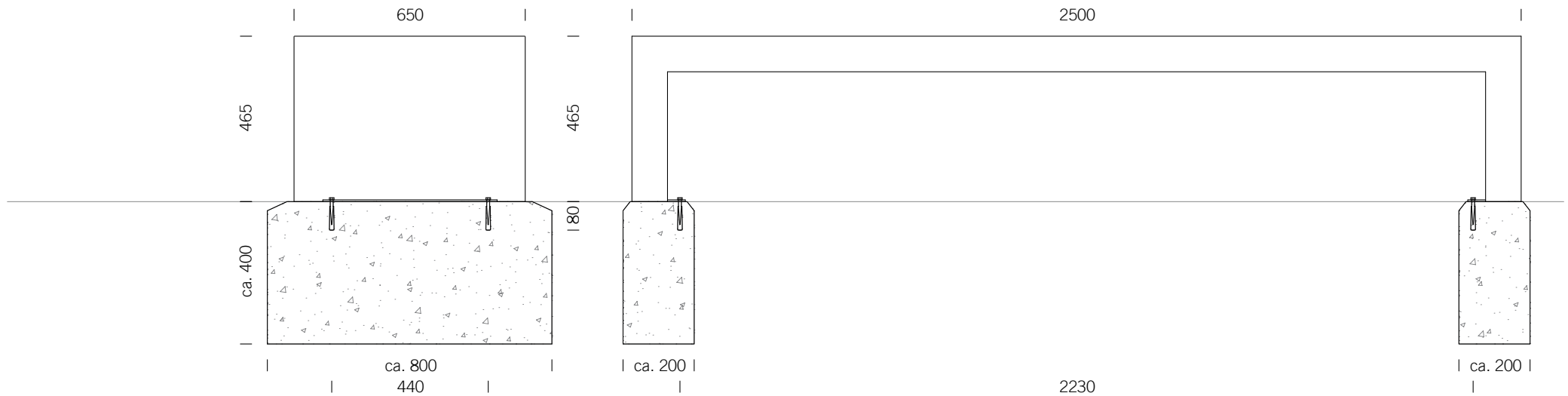

Foundations depend on local conditions - This is only a suggestion without warranty