

BOLLARD C900

BENKERTBÄNKE

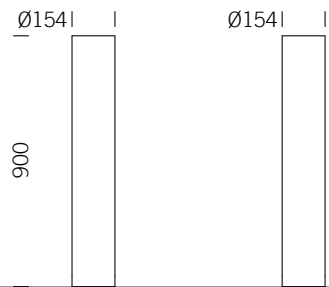

GROUND ANCHOR

1. Concrete-in, installation depth 400 mm
2. Bolt-on, installation depth 80 mm
3. Take-out, installation depth 330 mm

DIMENSIONS

Ø:	154 mm
Height:	900 mm
Weight:	8 kg

FRAME

Stainless steel type 304 | powder-coated



GROUND ANCHOR CONCRETE-IN, INSTALLATION DEPTH 400 MM

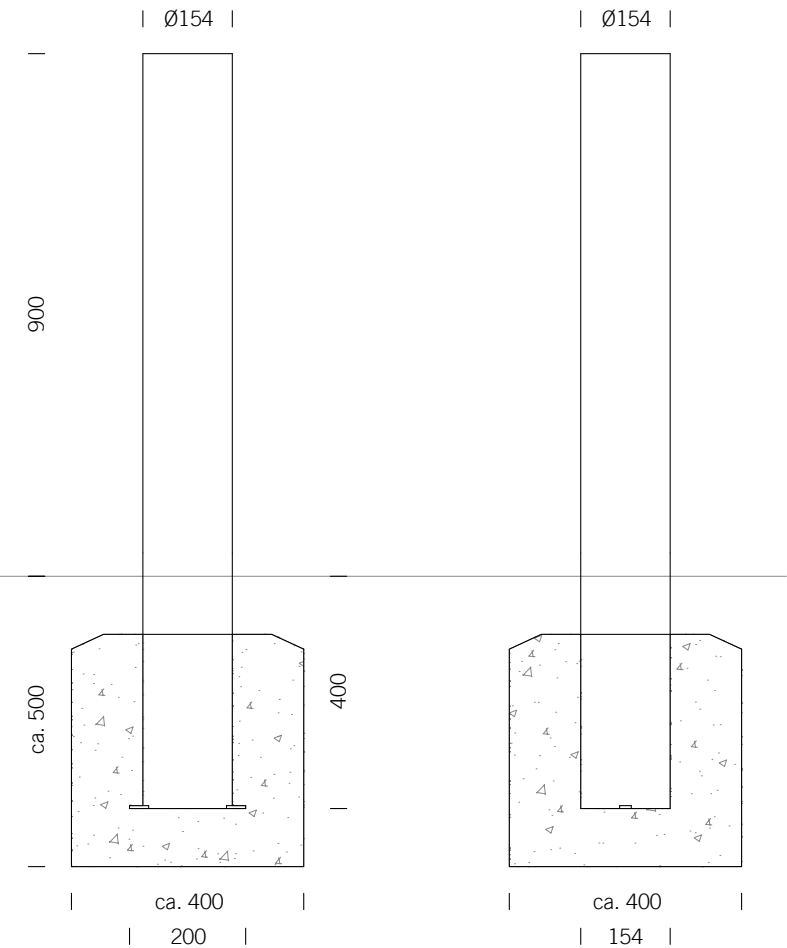

Foundations depend on local conditions - This is only a suggestion without warranty

GROUND ANCHOR BOLT-ON, INSTALLATION DEPTH 80 MM

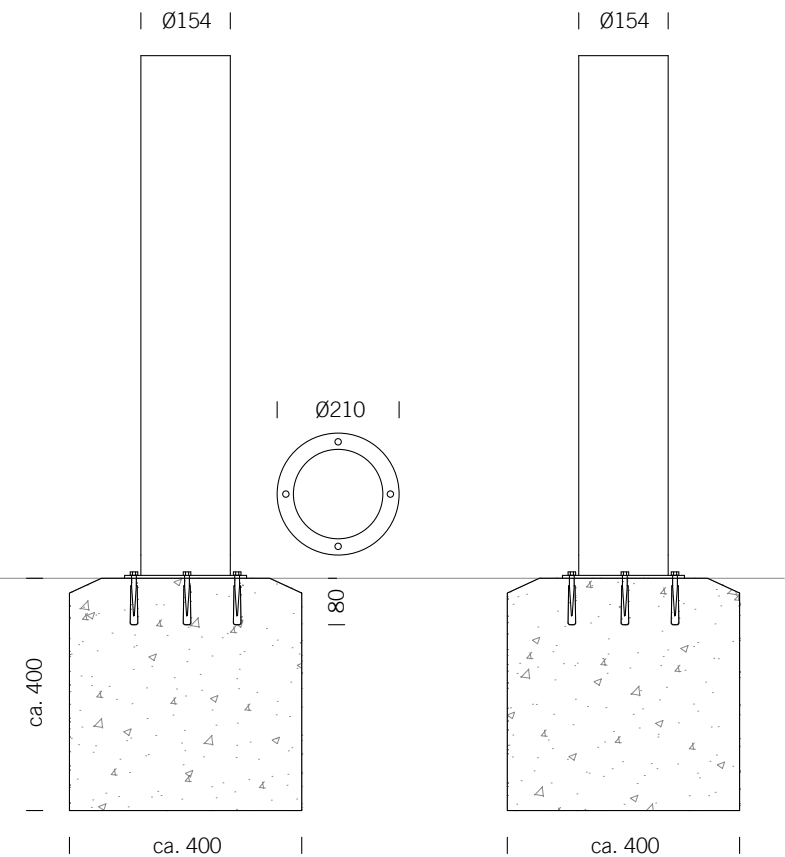

Foundations depend on local conditions - This is only a suggestion without warranty

GROUND ANCHOR TAKE-OUT, INSTALLATION DEPTH 330 MM

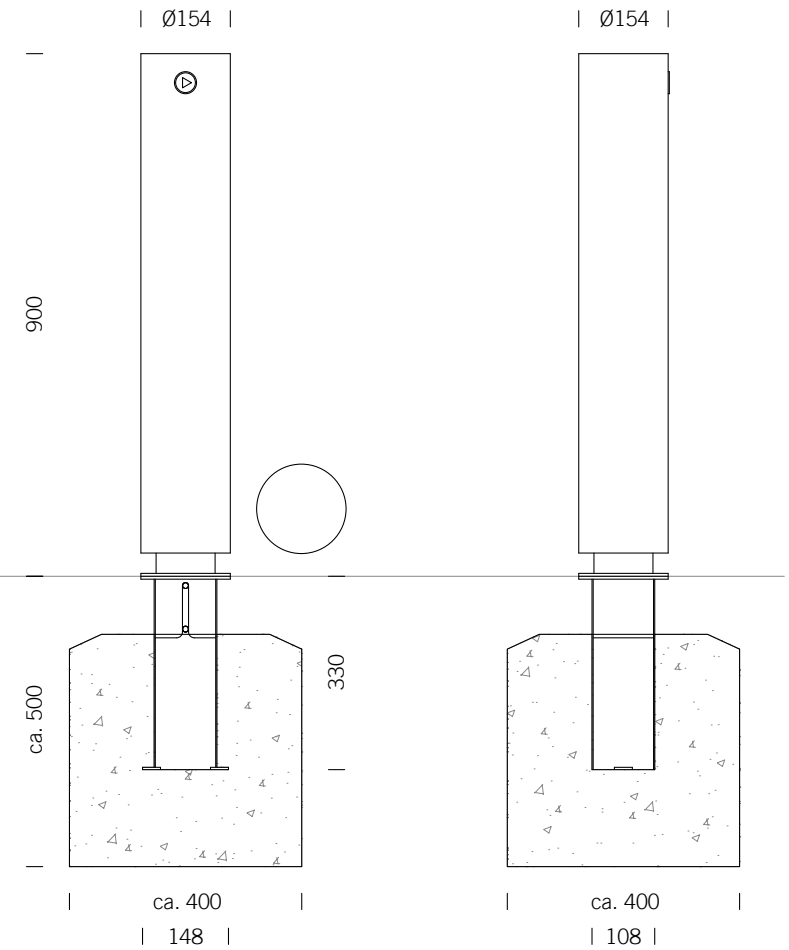

Foundations depend on local conditions - This is only a suggestion without warranty