

# BIKE STAND C1000

# BENKERTBÄNKE

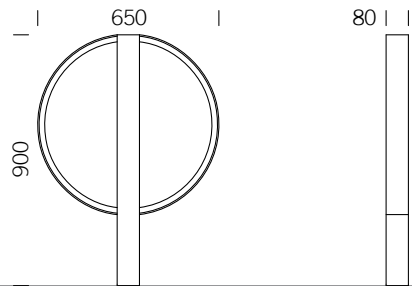

## GROUND ANCHOR

1. Concrete-in, installation depth 400 mm
2. Bolt-on, installation depth 80 mm

## DIMENSIONS

Length:	650 mm
Width:	80 mm
Height:	900 mm

## FRAME

Stainless steel type 304 | powder-coated



GROUND ANCHOR CONCRETE-IN, INSTALLATION DEPTH 400 MM

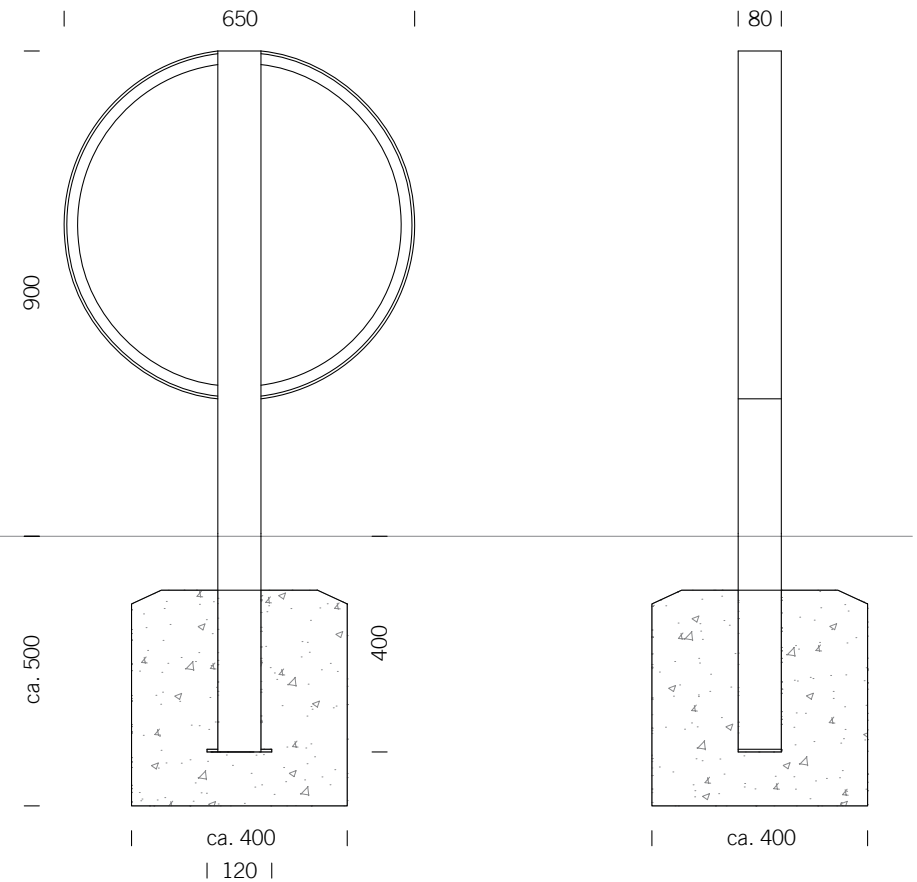

Foundations depend on local conditions - This is only a suggestion without warranty

GROUND ANCHOR BOLT-ON, INSTALLATION DEPTH 80 MM

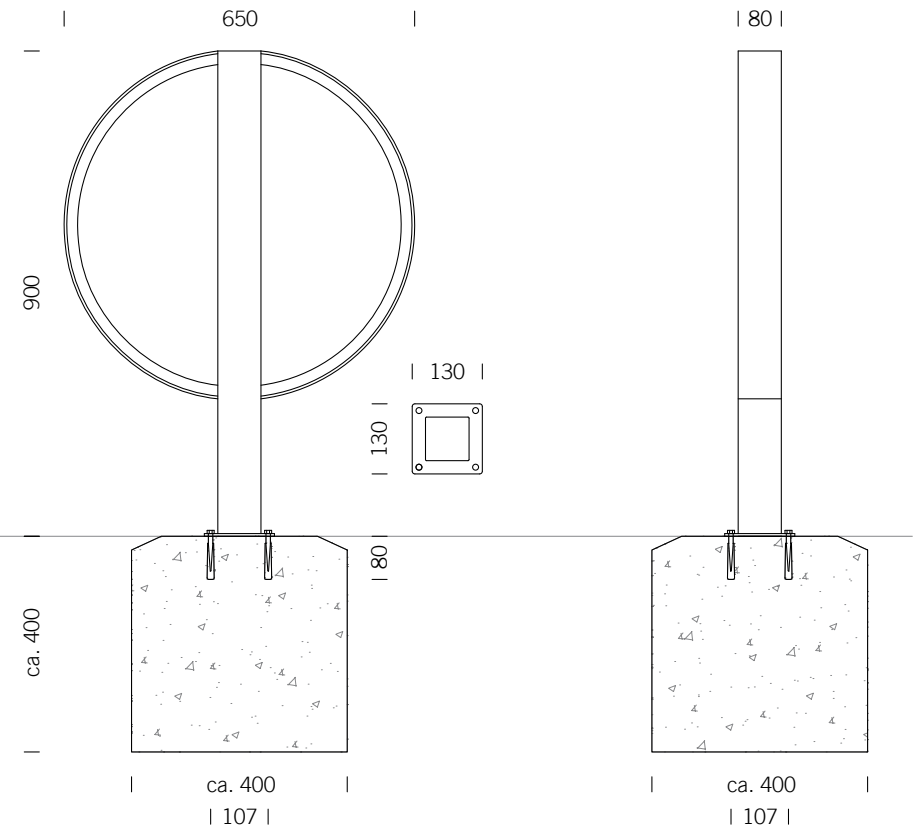

Foundations depend on local conditions - This is only a suggestion without warranty